

# TLV5580 8-BIT, 80 MSPS LOW-POWER A/D CONVERTER

SLAS205A – DECEMBER 1998 – REVISED JANUARY 1999

- **8-Bit Resolution 80 MSPS Sampling Analog-to-Digital Converter (ADC)**
- **Low Power Consumption: 165 mW Typ Using External references**
- **Wide Analog Input Bandwidth: 700 MHz Typ**
- **3.3 V Single-Supply Operation**
- **3.3 V TTL/CMOS-Compatible Digital I/O**
- **Internal Bottom and Top Reference Voltages**
- **Adjustable Reference Input Range**
- **Power Down (Standby) Mode**
- **Separate Power Down for Internal Voltage References**
- **Three-State Outputs**
- **28-Pin Small Outline IC (SOIC) and Thin Shrink SOP (TSSOP) Packages**
- **Applications**
  - Digital Communications (IF Sampling)
  - Flat Panel Displays
  - High-Speed DSP Front-End (TMS320C6000)
  - Medical Imaging
  - Graphics Processing (Scan Rate/Format Conversion)
  - DVD Read Channel Digitization

DW OR PW PACKAGE  
(TOP VIEW)

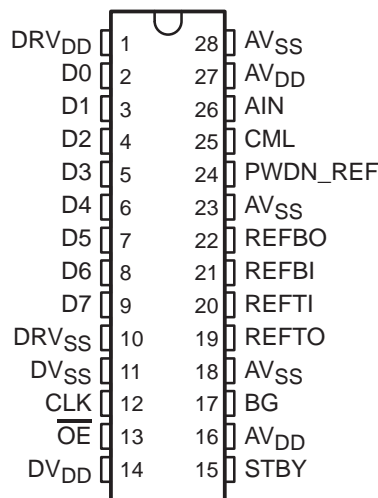

## description

The TLV5580 is an 8-bit 80 MSPS high-speed A/D converter. It converts the analog input signal into 8-bit binary-coded digital words up to a sampling rate of 80 MHz. All digital inputs and outputs are 3.3 V TTL/CMOS-compatible.

The device consumes very little power due to the 3.3 V supply and an innovative single-pipeline architecture implemented in a CMOS process. The user obtains maximum flexibility by setting both bottom and top voltage references from user-supplied voltages. If no external references are available, on-chip references are available for internal and external use. The full-scale range is 1 V<sub>pp</sub> up to 1.6 V<sub>pp</sub>, depending on the analog supply voltage. If external references are available, the internal references can be disabled independently from the rest of the chip, resulting in an even greater power saving.

While usable in a wide variety of applications, the device is specifically suited for the digitizing of high-speed graphics and for interfacing to LCD panels or LCD/DMD projection modules. Other applications include DVD read channel digitization, medical imaging and communications. This device is suitable for IF sampling of communication systems using sub-Nyquist sampling methods because of its high analog input bandwidth.



Please be aware that an important notice concerning availability, standard warranty, and use in critical applications of Texas Instruments semiconductor products and disclaimers thereto appears at the end of this data sheet.

PRODUCTION DATA information is current as of publication date. Products conform to specifications per the terms of Texas Instruments standard warranty. Production processing does not necessarily include testing of all parameters.

 **TEXAS  
INSTRUMENTS**

POST OFFICE BOX 655303 • DALLAS, TEXAS 75265

Copyright © 1999, Texas Instruments Incorporated

# TLV5580

## 8-BIT, 80 MSPS LOW-POWER A/D CONVERTER

SLAS205A – DECEMBER 1998 – REVISED JANUARY 1999

### AVAILABLE OPTIONS

| T <sub>A</sub> | PACKAGED DEVICES |            |
|----------------|------------------|------------|
|                | SOIC-28          | TSSOP-28   |
| 0°C to 70°C    | TLV5580CDW       | TLV5580CPW |
| -40°C to 85°C  | TLV5580IDW       | TLV5580IPW |

### functional block diagram

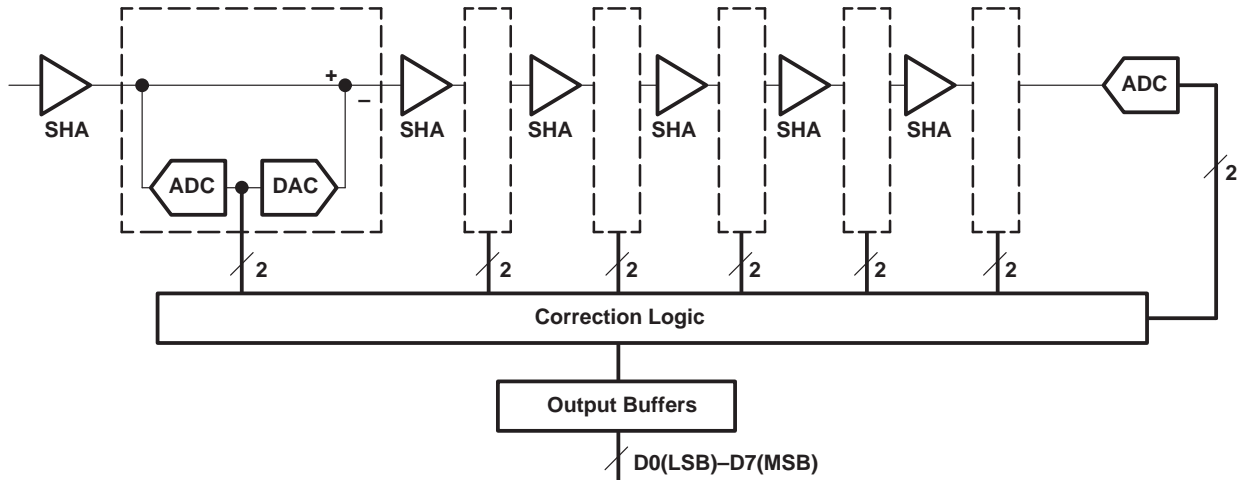

The single-pipeline architecture uses 6 ADC/DAC stages and one final flash ADC. Each stage produces a resolution of 2 bits. The correction logic generates its result using the 2-bit result from the first stage, 1 bit from each of the 5 succeeding stages, and 1 bit from the final stage in order to arrive at an 8-bit result. The correction logic guarantees no missing codes over the full operating temperature range.

circuit diagrams of inputs and outputs

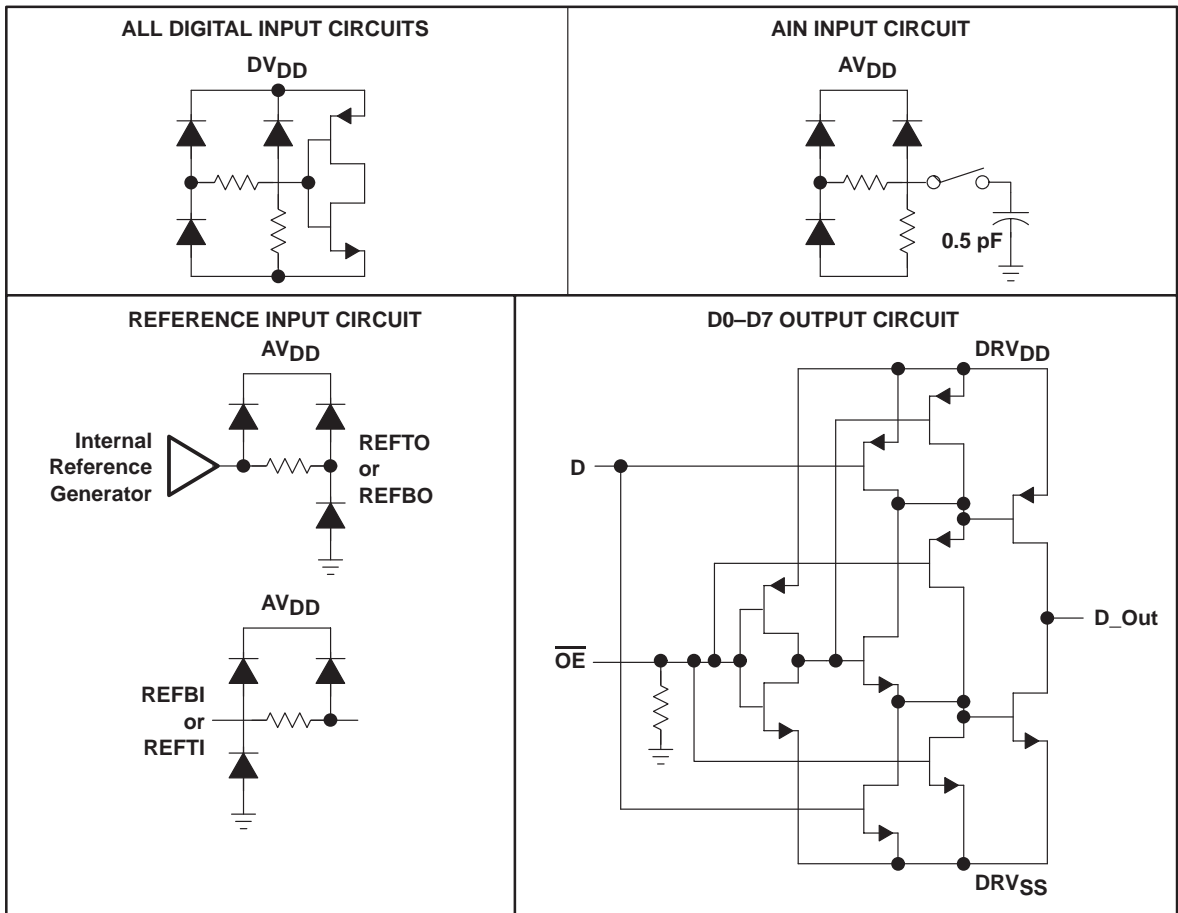

# TLV5580

## 8-BIT, 80 MSPS LOW-POWER A/D CONVERTER

SLAS205A – DECEMBER 1998 – REVISED JANUARY 1999

### Terminal Functions

| TERMINAL NAME          | NO.        | I/O | DESCRIPTION   |
|------------------------|------------|-----|---|
| AIN                    | 26         | I   | Analog input  |
| AV <sub>DD</sub>       | 16, 27     | I   | Analog supply voltage   |
| AV <sub>SS</sub>       | 18, 23, 28 | I   | Analog ground   |
| BG                     | 17         | O   | Band gap reference voltage. A 1 $\mu$ F capacitor (with an optional 0.1 $\mu$ F capacitor in parallel) should be connected between this terminal and AV <sub>SS</sub> for external filtering.   |
| CLK                    | 12         | I   | Clock input. The input is sampled on each rising edge of CLK.   |
| CML                    | 25         | O   | Common mode level. This voltage is equal to (AV <sub>DD</sub> – AV <sub>SS</sub> ) $\div$ 2. An external 0.1 $\mu$ F capacitor should be connected between this terminal and AV <sub>SS</sub> .   |
| D0 – D7                | 2 – 9      | O   | Data outputs. D7 is the MSB   |
| DRV <sub>DD</sub>      | 1          | I   | Supply voltage for digital output drivers   |
| DRV <sub>SS</sub>      | 10         | I   | Ground for digital output drivers   |
| DV <sub>DD</sub>       | 14         | I   | Digital supply voltage  |
| $\overline{\text{OE}}$ | 13         | I   | Output enable. When high the D0 – D7 outputs go in high-impedance mode.   |
| DV <sub>SS</sub>       | 11         | I   | Digital ground  |
| PWDN_REF               | 24         | I   | Power down for internal reference voltages. A high on this terminal will disable the internal reference circuit.  |
| REFBI                  | 21         | I   | Reference voltage bottom input. The voltage at this terminal defines the bottom reference voltage for the ADC. It can be connected to REFBO or to an externally generated reference level. Sufficient filtering should be applied to this input. The use a 0.1 $\mu$ F capacitor connected between REFBI and AV <sub>SS</sub> is recommended. Additionally, a 0.1 $\mu$ F capacitor can be connected between REFTI and REFBI. |
| REFBO                  | 22         | O   | Reference voltage bottom output. An internally generated reference is available at this terminal. It can be connected to REFBI or left unconnected. A 1 $\mu$ F capacitor between REFBO and AV <sub>SS</sub> will provide sufficient decoupling required for this output.   |
| REFTI                  | 20         | I   | Reference voltage top input. The voltage at this terminal defines the top reference voltage for the ADC. It can be connected to REFTO or to an externally generated reference level. Sufficient filtering should be applied to this input. The use of a 0.1 $\mu$ F capacitor between REFTI and AV <sub>SS</sub> is recommended. Additionally, a 0.1 $\mu$ F capacitor can be connected between REFTI and REFBI.              |
| REFTO                  | 19         | O   | Reference voltage top output. An internally generated reference is available at this terminal. It can be connected to REFTI or left unconnected. A 1 $\mu$ F capacitor between REFTO and AV <sub>SS</sub> will provide sufficient decoupling required for this output.  |
| STBY                   | 15         | I   | Standby input. A high level on this input enables a powerdown mode.   |



# TLV5580

## 8-BIT, 80 MSPS LOW-POWER A/D CONVERTER

SLAS205A – DECEMBER 1998 – REVISED JANUARY 1999

### absolute maximum ratings over operating free-air temperature (unless otherwise noted)†

|  |       |                             |
|--|-------|-----------------------------|
| Supply voltage: $AV_{DD}$ to AGND, $DV_{DD}$ to DGND   | ..... | -0.5 V to 4.5 V             |
| Supply voltage: $AV_{DD}$ to $DV_{DD}$ , AGND to DGND  | ..... | -0.5 V to 0.5 V             |
| Digital input voltage range to DGND  | ..... | -0.5 V to $DV_{DD} + 0.5$ V |
| Analog input voltage range to AGND   | ..... | -0.5 V to $AV_{DD} + 0.5$ V |
| Digital output voltage applied from external source to DGND  | ..... | -0.5 V to $DV_{DD} + 0.5$ V |
| Reference voltage input range to AGND: $V_{(REFTI)}$ , $V_{(REFTO)}$ , $V_{(REFBI)}$ , $V_{(REFBO)}$ | ..... | -0.5 V to $AV_{DD} + 0.5$ V |
| Operating free-air temperature range, $T_A$ : TLV5580C   | ..... | 0°C to 70°C                 |
| TLV5580I   | ..... | -40°C to 85°C               |
| Storage temperature range, $T_{stg}$   | ..... | -55°C to 150°C              |

† Stresses beyond those listed under “absolute maximum ratings” may cause permanent damage to the device. These are stress ratings only, and functional operation of the device at these or any other conditions beyond those indicated under “recommended operating conditions” is not implied. Exposure to absolute-maximum-rated conditions for extended periods may affect device reliability.

### recommended operating conditions over operating free-temperature range

#### power supply

|                |            | MIN | NOM | MAX | UNIT |
|----------------|------------|-----|-----|-----|------|
| Supply voltage | $AV_{DD}$  |     |     |     |      |
|                | $DV_{DD}$  | 3   | 3.3 | 3.6 | V    |
|                | $DRV_{DD}$ |     |     |     |      |

#### analog and reference inputs

|   | MIN           | NOM                   | MAX                   | UNIT |
|---|---------------|-----------------------|-----------------------|------|
| Reference input voltage (top), $V_{(REFTI)}$                | (NOM) - 0.2   | 2 + ( $AV_{DD} - 3$ ) | (NOM) + 0.2           | V    |
| Reference input voltage (bottom), $V_{(REFBI)}$             | 0.8           | 1                     | 1.2                   | V    |
| Reference voltage differential, $V_{(REFTI)} - V_{(REFBI)}$ |               |                       | 1 + ( $AV_{DD} - 3$ ) | V    |
| Analog input voltage, $V_{(AIN)}$                           | $V_{(REFBI)}$ |                       | $V_{(REFTI)}$         | V    |

#### digital inputs

|  | MIN  | NOM | MAX                  | UNIT |
|--|------|-----|----------------------|------|
| High-level input voltage, $V_{IH}$             | 2.0  |     | $DV_{DD}$            | V    |
| Low-level input voltage, $V_{IL}$              | DGND |     | 0.2 $\times DV_{DD}$ | V    |
| Clock period, $t_c$                            | 12.5 |     |                      | ns   |
| Pulse duration, clock high, $t_w(\text{CLKH})$ | 5.25 |     |                      | ns   |
| Pulse duration, clock low, $t_w(\text{CLKL})$  | 5.25 |     |                      | ns   |



# TLV5580

## 8-BIT, 80 MSPS LOW-POWER A/D CONVERTER

SLAS205A – DECEMBER 1998 – REVISED JANUARY 1999

electrical characteristics over recommended operating conditions with  $f_{CLK} = 80$  MSPS and use of external voltage references (unless otherwise noted)

### power supply

| PARAMETER   |                          | TEST CONDITIONS   | MIN | TYP | MAX | UNIT |
|-------------|--------------------------|---|-----|-----|-----|------|
| $I_{DD}$    | Operating supply current | $AV_{DD} = DV_{DD} = 3.3$ V, $DRV_{DD} = 3$ V,<br>$C_L = 15$ pF, $V_I = 1$ MHz, $-1$ dBFS |     | 57  | 71  | mA   |
|             |                          |   |     | 3   | 3.6 |      |
|             |                          |   |     | 5   | 7.5 |      |
| $P_D$       | Power dissipation        | PWDN_REF = L  |     | 213 | 270 | mW   |
|             |                          | PWDN_REF = H  |     | 165 | 210 |      |
| $P_D(STBY)$ | Standby power            | STBY = H, CLK held high or low  |     | 11  | 15  |      |

### digital logic inputs

| PARAMETER |   | TEST CONDITIONS  | MIN | TYP | MAX | UNIT    |
|-----------|---|--|-----|-----|-----|---------|
| $I_{IH}$  | High-level input current on CLK <sup>†</sup>  | $AV_{DD} = DV_{DD} = DRV_{DD} = CLK = 3.6$ V                     |     |     | 10  | $\mu$ A |
| $I_{IL}$  | Low-level input current on digital inputs ( $\overline{OE}$ , STDBY, PWDN_REF, CLK) | $AV_{DD} = DV_{DD} = DRV_{DD} = 3.6$ V,<br>Digital inputs at 0 V |     |     | 10  | $\mu$ A |
| $C_I$     | Input capacitance   |  |     | 5   |     | pF      |

<sup>†</sup>  $I_{IH}$  leakage current on other digital inputs ( $\overline{OE}$ , STDBY, PWDN\_REF) is not measured since these inputs have an internal pull-down resistor of 4 K $\Omega$  to DGND.

### logic outputs

| PARAMETER |   | TEST CONDITIONS   | MIN | TYP | MAX | UNIT    |
|-----------|---|---|-----|-----|-----|---------|
| $V_{OH}$  | High-level output voltage                         | $AV_{DD} = DV_{DD} = DRV_{DD} = 3$ V at $I_{OH} = 50$ $\mu$ A,<br>Digital output forced high  | 2.8 |     |     | V       |
| $V_{OL}$  | Low-level output voltage                          | $AV_{DD} = DV_{DD} = DRV_{DD} = 3.6$ V at $I_{OL} = 50$ $\mu$ A,<br>Digital output forced low |     |     | 0.1 | V       |
| $C_O$     | Output capacitance                                |   |     | 5   |     | pF      |
| $I_{OZH}$ | High-impedance state output current to high level | $AV_{DD} = DV_{DD} = DRV_{DD} = 3.6$ V  |     |     | 10  | $\mu$ A |
| $I_{OZL}$ | High-impedance state output current to low level  |   |     |     | 10  | $\mu$ A |

# TLV5580

## 8-BIT, 80 MSPS LOW-POWER A/D CONVERTER

SLAS205A – DECEMBER 1998 – REVISED JANUARY 1999

**electrical characteristics over recommended operating conditions with  $f_{CLK} = 80$  MSPS and use of external voltage references (unless otherwise noted)**

### dc accuracy

| PARAMETER                             | TEST CONDITIONS   | MIN   | TYP       | MAX     | UNIT |     |
|---------------------------------------|---|---|-----------|---------|------|-----|
| Integral nonlinearity (INL), best-fit | Internal references (see Note 1)  | $T_A = 25^\circ\text{C}$                        | -2        | $\pm 1$ | 2    | LSB |
|                                       |   | $T_A = -40^\circ\text{C}$ to $85^\circ\text{C}$ | -2.4      | $\pm 1$ | 2.4  | LSB |
| Differential nonlinearity (DNL)       | Internal references (see Note 2), $T_A = -40^\circ\text{C}$ to $85^\circ\text{C}$ | -1  | $\pm 0.6$ | 1.3     | LSB  |     |
| Zero error                            | $AV_{DD} = DV_{DD} = 3.3\text{ V}$ , $DRV_{DD} = 3\text{ V}$ See Note 3           |   |           | 5       | %FS  |     |
| Full scale error                      |   |   |           | 5       | %FS  |     |

- NOTES:
- Integral nonlinearity refers to the deviation of each individual code from a line drawn from zero to full scale. The point used as zero occurs 1/2 LSB before the first code transition. The full-scale point is defined as a level 1/2 LSB beyond the last code transition. The deviation is measured from the center of each particular code to the true straight line between these two endpoints.
  - An ideal ADC exhibits code transitions that are exactly 1 LSB apart. DNL is the deviation from this ideal value. Therefore this measure indicates how uniform the transfer function step sizes are. The ideal step size is defined here as the step size for the device under test (i.e., (last transition level – first transition level)  $\div$  ( $2^n - 2$ )). Using this definition for DNL separates the effects of gain and offset error. A minimum DNL better than -1 LSB ensures no missing codes.
  - Zero error is defined as the difference in analog input voltage – between the ideal voltage and the actual voltage – that will switch the ADC output from code 0 to code 1. The ideal voltage level is determined by adding the voltage corresponding to 1/2 LSB to the bottom reference level. The voltage corresponding to 1 LSB is found from the difference of top and bottom references divided by the number of ADC output levels (256).

Full-scale error is defined as the difference in analog input voltage – between the ideal voltage and the actual voltage – that will switch the ADC output from code 254 to code 255. The ideal voltage level is determined by subtracting the voltage corresponding to 1.5 LSB from the top reference level. The voltage corresponding to 1 LSB is found from the difference of top and bottom references divided by the number of ADC output levels (256).

### analog input

| PARAMETER               | TEST CONDITIONS | MIN | TYP | MAX | UNIT |
|-------------------------|-----------------|-----|-----|-----|------|
| $C_I$ Input capacitance |                 |     | 4   |     | pF   |

### reference input ( $AV_{DD} = DV_{DD} = DRV_{DD} = 3.6\text{ V}$ )

| PARAMETER                            | TEST CONDITIONS | MIN | TYP | MAX | UNIT     |
|--------------------------------------|-----------------|-----|-----|-----|----------|
| $R_{ref}$ Reference input resistance |                 |     | 200 |     | $\Omega$ |
| $I_{ref}$ Reference input current    |                 |     | 5   |     | mA       |

### reference outputs

| PARAMETER   | TEST CONDITIONS   | MIN  | TYP                          | MAX  | UNIT |
|---|---|------|------------------------------|------|------|
| $V(\text{REFTO})$ Reference top offset voltage    | Absolute min/max values valid and tested for $AV_{DD} = 3.3\text{ V}$ | 2.07 | $2 + [(AV_{DD} - 3) \div 2]$ | 2.21 | V    |
| $V(\text{REFBO})$ Reference bottom offset voltage |   | 1.09 | $1 + [(AV_{DD} - 3) \div 2]$ | 1.21 | V    |

# TLV5580

## 8-BIT, 80 MSPS LOW-POWER A/D CONVERTER

SLAS205A – DECEMBER 1998 – REVISED JANUARY 1999

**electrical characteristics over recommended operating conditions with  $f_{CLK} = 80$  MSPS and use of external voltage references (unless otherwise noted) (continued)**

### dynamic performance†

| PARAMETER  | TEST CONDITIONS  | MIN   | TYP   | MAX | UNIT |
|--|--|-------|-------|-----|------|
| Effective number of bits, ENOB                         | $f_{IN} = 1$ MHz   | 6.6   | 7.0   |     | Bits |
|  | $f_{IN} = 4.43$ MHz  | 6.6   | 7.0   |     |      |
|  | $f_{IN} = 15$ MHz  |       | 6.5   |     |      |
|  | $f_{IN} = 76$ MHz  |       | 6.6   |     |      |
| Signal-to-total harmonic distortion + noise, S/(THD+N) | $f_{IN} = 1$ MHz   | 41.5  | 43.5  |     | dB   |
|  | $f_{IN} = 4.43$ MHz  | 41.5  | 43.5  |     |      |
|  | $f_{IN} = 15$ MHz  |       | 41    |     |      |
|  | $f_{IN} = 76$ MHz  |       | 41.5  |     |      |
| Total harmonic distortion (THD)                        | $f_{IN} = 1$ MHz   | -46   | -50   |     | dB   |
|  | $f_{IN} = 4.43$ MHz  | -45.5 | -49   |     |      |
|  | $f_{IN} = 15$ MHz  |       | -44   |     |      |
|  | $f_{IN} = 76$ MHz  |       | -45.5 |     |      |
| Spurious free dynamic range (SFDR)                     | $f_{IN} = 1$ MHz   | 48    | 53    |     | dB   |
|  | $f_{IN} = 4.43$ MHz  | 48    | 53    |     |      |
|  | $f_{IN} = 15$ MHz  |       | 46.5  |     |      |
|  | $f_{IN} = 76$ MHz  |       | 48.5  |     |      |
| Analog input full-power bandwidth, BW                  | See Note 4   |       | 700   |     | MHz  |
| Differential phase, DP                                 | $f_{CLK} = 40$ MHz, $f_{IN} = 4.43$ MHz,<br>20 IRE amplitude vs. full-scale of 140 IRE |       | 0.8   |     | °    |
| Differential gain, DG                                  |  |       | 0.6   |     | %    |

† Based on analog input voltage of -1 dBFS referenced to a  $1.3 V_{pp}$  full-scale input range and using the external voltage references at  $f_{CLK} = 80$  MSPS with  $AV_{DD} = DV_{DD} = 3.3$  V and  $DRV_{DD} = 3.0$  V at 25°C.

NOTE 4: The analog input bandwidth is defined as the maximum frequency of a -1 dBFS input sine that can be applied to the device for which an extra 3 dB attenuation is observed in the reconstructed output signal.





electrical characteristics over recommended operating conditions with  $f_{CLK} = 80$  MSPS and use of external voltage references (unless otherwise noted) (continued)

timing requirements

| PARAMETER     |   | TEST CONDITIONS                  | MIN | TYP | MAX | UNIT       |
|---------------|---|----------------------------------|-----|-----|-----|------------|
| $f_{clk}$     | Maximum conversion rate                       |                                  | 80  |     |     | MHz        |
| $f_{clk}$     | Minimum conversion rate                       |                                  |     |     | 10  | kHz        |
| $t_{d(o)}$    | Output delay time (see Figure 1)              | $C_L = 10$ pF, See Notes 5 and 6 |     |     | 9   | ns         |
| $t_{h(o)}$    | Output hold time                              | $C_L = 2$ pF, See Note 5         | 2   |     |     | ns         |
| $t_{d(pipe)}$ | Pipeline delay (latency)                      | See Note 6                       | 4.5 | 4.5 | 4.5 | CLK cycles |
| $t_{d(a)}$    | Aperture delay time                           | See Note 5                       |     | 3   |     | ns         |
| $t_{j(a)}$    | Aperture jitter                               |                                  |     | 1.5 |     | ps, rms    |
| $t_{dis}$     | Disable time, $\overline{OE}$ rising to Hi-Z  |                                  |     | 5   | 8   | ns         |
| $t_{en}$      | Enable, $\overline{OE}$ falling to valid data |                                  |     | 5   | 8   | ns         |

NOTES: 5. Output timing  $t_{d(o)}$  is measured from the 1.5 V level of the CLK input falling edge to the 10%/90% level of the digital output. The digital output load is not higher than 10 pF.

Output hold time  $t_{h(o)}$  is measured from the 1.5 V level of the CLK input falling edge to the 10%/90% level of the digital output. The digital output is load is not less than 2 pF.

Aperture delay  $t_{d(A)}$  is measured from the 1.5 V level of the CLK input to the actual sampling instant.

The OE signal is asynchronous.

OE timing  $t_{dis}$  is measured from the  $V_{IH(MIN)}$  level of OE to the high-impedance state of the output data. The digital output load is not higher than 10 pF.

OE timing  $t_{en}$  is measured from the  $V_{IL(MAX)}$  level of OE to the instant when the output data reaches  $V_{OH(min)}$  or  $V_{OL(max)}$  output levels. The digital output load is not higher than 10 pF.

6. The number of clock cycles between conversion initiation on an input sample and the corresponding output data being made available from the ADC pipeline. Once the data pipeline is full, new valid output data is provided on every clock cycle. In order to know when data is stable on the output pins, the output delay time  $t_{d(o)}$  (i.e., the delay time through the digital output buffers) needs to be added to the pipeline latency. Note that since the max.  $t_{d(o)}$  is more than 1/2 clock period at 80 MHz; data cannot be reliably clocked in on a rising edge of CLK at this speed. The falling edge should be used.

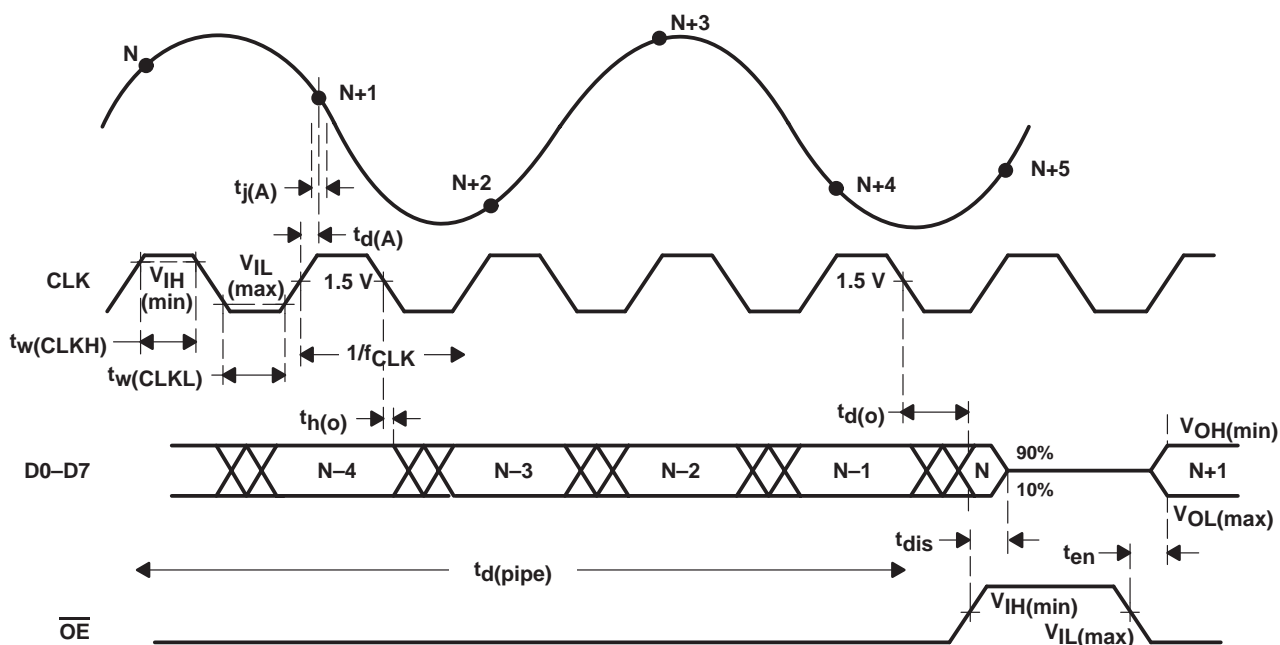

Figure 1. Timing Diagram

# TLV5580 8-BIT, 80 MSPS LOW-POWER A/D CONVERTER

SLAS205A – DECEMBER 1998 – REVISED JANUARY 1999

---

## performance plots at 25°C

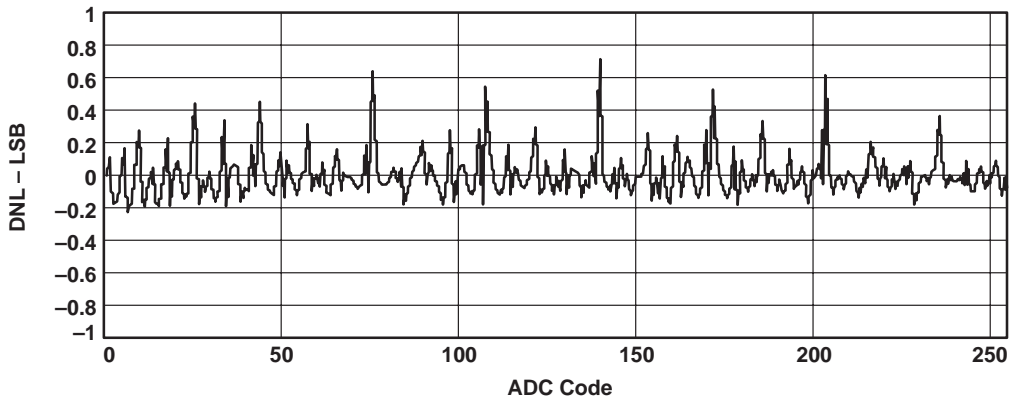

Figure 2. DNL vs Input Code At 80 MSPS (With External Reference, PW Package)

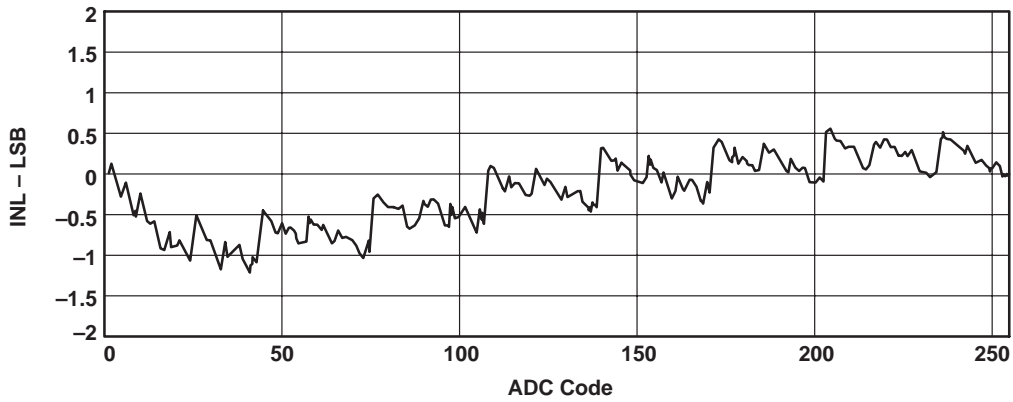

Figure 3. INL vs Input Code At 80 MSPS (With External Reference, PW Package)

performance plots at 25°C (continued)

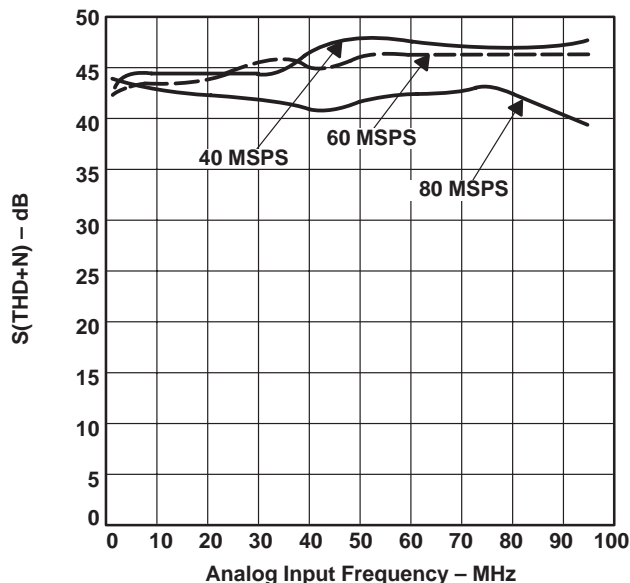

Figure 4.  $S/(THD+N)$  vs  $V_{IN}$  At 80 MSPS (Internal Reference), 60 MSPS (External Reference), 40 MSPS (External Reference)

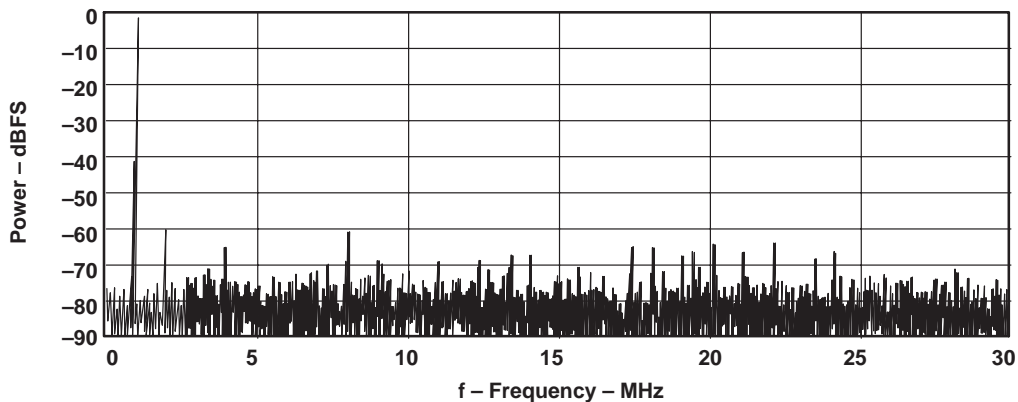

Figure 5. Spectral Plot  $f_{IN} = 1.011$  MHz At 60 MSPS

# TLV5580 8-BIT, 80 MSPS LOW-POWER A/D CONVERTER

SLAS205A – DECEMBER 1998 – REVISED JANUARY 1999

## performance plots at 25°C (continued)

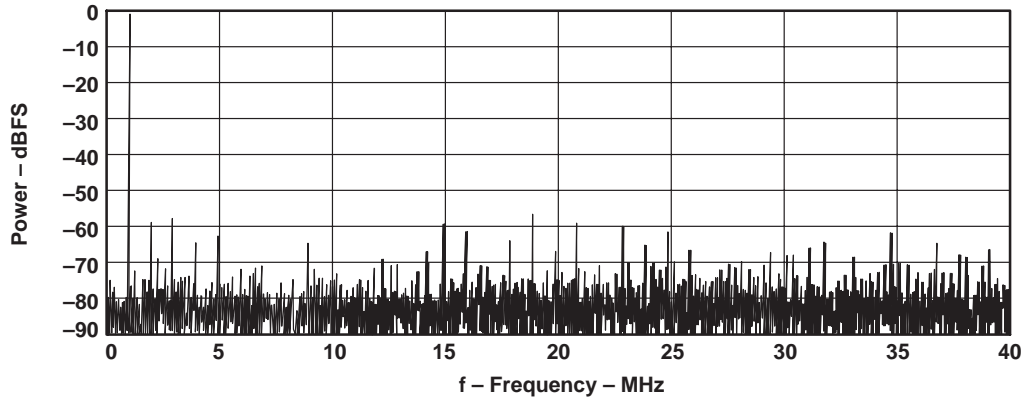

Figure 6. Spectral Plot  $f_{IN} = 0.996$  MHz At 80MSPS

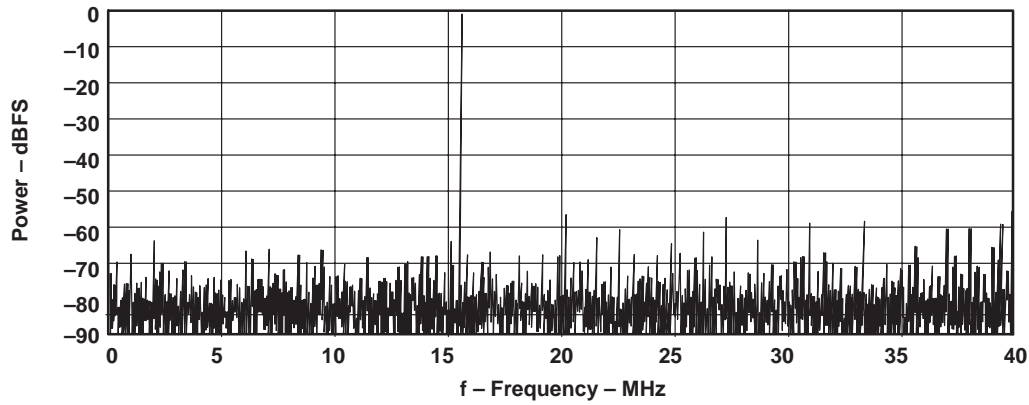

Figure 7. Spectral Plot  $f_{IN} = 15.527$  MHz At 80 MSPS

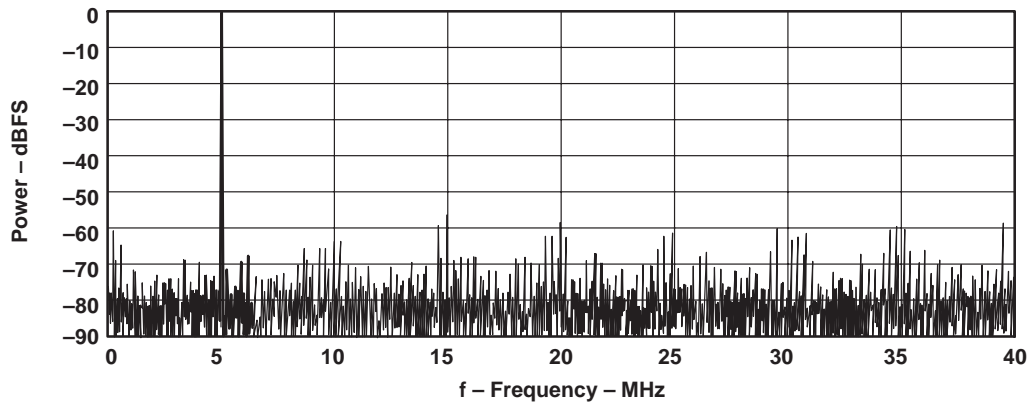

Figure 8. Spectral Plot  $f_{IN} = 75.02$  MHz At 80MSPS  
(Plot shows folded spectrum of undersampled input signal)

performance plots at 25°C (continued)

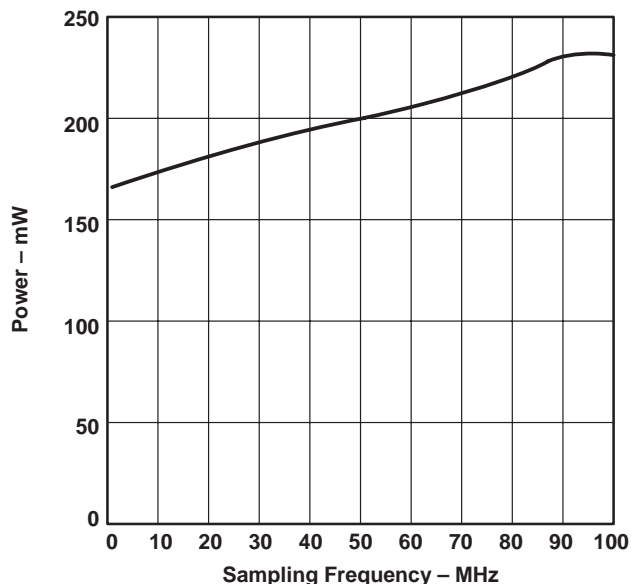

Figure 9. Power vs  $f_{CLK}$   
At  $V_{IN} = 1$  MHz,  $-1$  dBFS

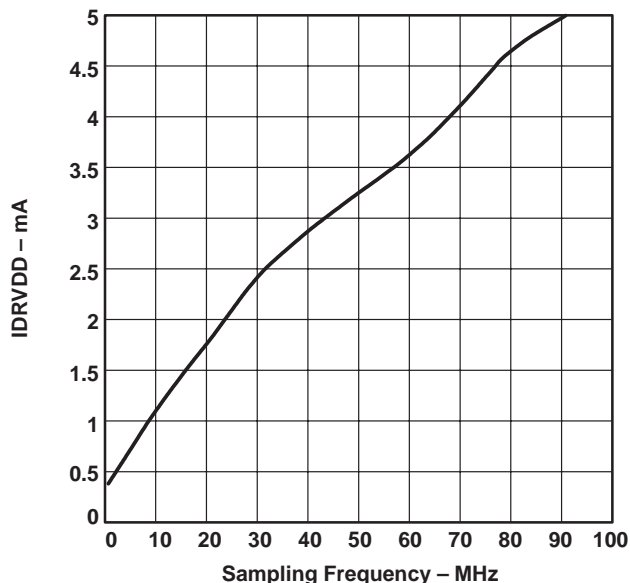

Figure 10.  $IDR_{VDD}$  vs  $f_{CLK}$   
At  $V_{IN} = 1$  MHz,  $-1$  dBFS

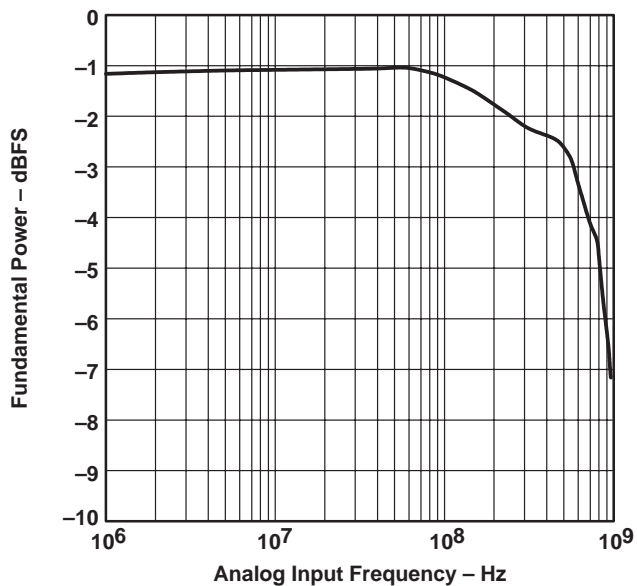

Figure 11. ADC Output Power With Respect To  $-1$  dBFS  $V_{IN}$   
(Internal Reference, DW Package)

# TLV5580

## 8-BIT, 80 MSPS LOW-POWER A/D CONVERTER

SLAS205A – DECEMBER 1998 – REVISED JANUARY 1999

### PRINCIPLE OF OPERATION

The TLV5580 implements a high-speed 80 Msp/s converter in a cost-effective CMOS process. Powered from 3.3 V, the single-pipeline design architecture ensures low-power operation and 8-bit accuracy. Signal input and clock signals are all single-ended. The digital inputs are 3.3 V TTL/CMOS compatible. Internal voltage references are included for both bottom and top voltages. Therefore the converter forms a self-contained solution. Alternatively the user may apply externally generated reference voltages. In doing so, both input offset and input range can be modified to suit the application.

A high-speed sampling-and-hold captures the analog input signal. Multiple stages will generate the output code with a pipeline delay of 4.5 CLK cycles. Correction logic combines the multistage data and aligns the 8-bit output word. All digital logic operates at the rising edge of CLK.

### analog input

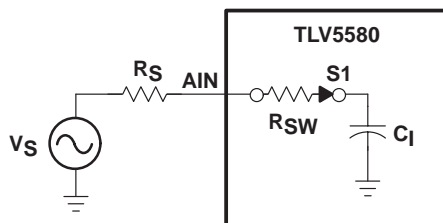

Figure 12. Simplified Equivalent Input Circuit

A first-order approximation for the equivalent analog input circuit of the TLV5580 is shown in Figure 12. The equivalent input capacitance  $C_1$  is 4 pF typical. The input must charge/discharge this capacitance within the sample period of one half clock cycle. When a full-scale voltage step is applied, the input source provides the charging current through the switch resistance  $R_{SW}$  (200  $\Omega$ ) of S1 and quickly settles. In this case the input impedance is low. Alternatively, when the source voltage equals the value previously stored on  $C_1$ , the hold capacitor requires no input current and the equivalent input impedance is very high.

To maintain the frequency performance outlined in the specifications, the total source impedance should be limited to about 80  $\Omega$ , as follows from the equation with  $f_{CLK} = 80$  MHz,  $C_1 = 4$  pF,  $R_{SW} = 200$   $\Omega$ :

$$R_S < \left[ 1 \div \left( 2f_{CLK} \times C_1 \times \ln(256) \right) \right] - R_{SW}$$

So, for applications running at a lower  $f_{CLK}$ , the total source resistance can increase proportionally.

PRINCIPLE OF OPERATION

dc coupled input

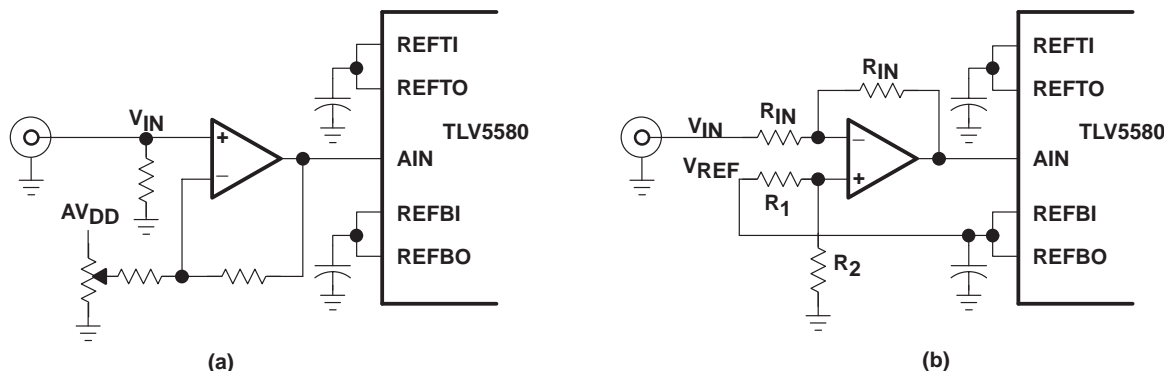

Figure 13. DC-Coupled Input Circuit

For dc-coupled systems an opamp can level-shift a ground-referenced input signal. A circuit as shown in Figure 13(a) is acceptable. Alternatively, the user might want a bipolar shift together with the bottom reference voltage as seen in Figure 13(b). In this case the AIN voltage is given by:

$$A_{IN} = 2 \times R_2 \div (R_1 + R_2) \times V_{REF} - V_{IN}$$

ac coupled input

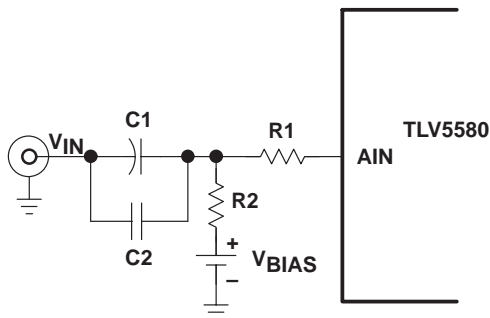

Figure 14. AC-Coupled Input Circuit

For many applications, especially in single supply operation, ac coupling offers a convenient way for biasing the analog input signal at the proper signal range. Figure 14 shows a typical configuration. To maintain the outlined specifications, the component values need to be carefully selected. The most important issue is the positioning of the 3 dB high-pass corner point  $f_{-3\text{dB}}$ , which is a function of  $R_2$  and the parallel combination of  $C_1$  and  $C_2$ , called  $C_{eq}$ . This is given by the following equation:

$$f_{-3\text{dB}} = 1 \div (2\pi \times R_2 \times C_{eq})$$

where  $C_{eq}$  is the parallel combination of  $C_1$  and  $C_2$ .

Since  $C_1$  is typically a large electrolytic or tantalum capacitor, the impedance becomes inductive at higher frequencies. Adding a small ceramic or polystyrene capacitor,  $C_2$  of approximately 0.01  $\mu\text{F}$ , which is not inductive within the frequency range of interest, maintains low impedance. If the minimum expected input signal frequency is 20 kHz, and  $R_2$  equals 1 k $\Omega$  and  $R_1$  equals 50  $\Omega$ , the parallel capacitance of  $C_1$  and  $C_2$  must be a minimum of 8 nF to avoid attenuating signals close to 20 kHz.

# TLV5580

## 8-BIT, 80 MSPS LOW-POWER A/D CONVERTER

SLAS205A – DECEMBER 1998 – REVISED JANUARY 1999

### PRINCIPLE OF OPERATION

#### reference terminals

The voltages on terminals REFBI and REFTI determine the TLV5580's input range. Since the device has an internal voltage reference generator with outputs available on REFBO respectively REFTO, corresponding terminals can be directly connected externally to provide a contained ADC solution. Especially at higher sampling rates, it is advantageous to have a wider analog input range. The wider analog input range is achievable by using external voltage references (e.g., at  $AV_{DD} = 3.3\text{ V}$ , the full scale range can be extended from 1 Vpp (internal reference) to 1.3 Vpp (external reference) as shown in Table 1). These voltages should not be derived via a voltage divider from a power supply source. Instead, use a bandgap-derived voltage reference to derive both references via an opamp circuit. Refer to the schematic of the TLV5580 evaluation module for an example circuit.

When using external references, the full-scale ADC input range and its dc position can be adjusted. The full-scale ADC range is always equal to  $V_{REFT} - V_{REFB}$ . The maximum full-scale range is dependent on  $AV_{DD}$  as shown in the specification section. In addition to the limitation on their difference,  $V_{REFT}$  and  $V_{REFB}$  each also have limits on their useful range. These limits are also dependent on  $AV_{DD}$ .

Table 3 summarizes these limits for 3 cases.

**Table 1. Recommended Operating Modes**

| $AV_{DD}$ | $V_{REFB}(\text{min})$ | $V_{REFB}(\text{max})$ | $V_{REFT}(\text{min})$ | $V_{REFT}(\text{max})$ | $[V_{REFT}-V_{REFB}]_{\text{max}}$ |
|-----------|------------------------|------------------------|------------------------|------------------------|------------------------------------|
| 3 V       | 0.8 V                  | 1.2 V                  | 1.8 V                  | 2.2 V                  | 1 V                                |
| 3.3 V     | 0.8 V                  | 1.2 V                  | 2.1 V                  | 2.5 V                  | 1.3 V                              |
| 3.6 V     | 0.8 V                  | 1.2 V                  | 2.4 V                  | 2.8 V                  | 1.6 V                              |

#### digital inputs

The digital inputs are CLK, STDBY, PWDN\_REF, and  $\overline{OE}$ . All these signals, except CLK, have an internal pull-down resistor to connect to digital ground. This provides a default active operation mode using internal references when left unconnected.

The CLK signal at high frequencies should be considered as an analog input. Overshoot/undershoot should be minimized by proper termination of the signal close to the TLV5580. An important cause of performance degradation for a high-speed ADC is clock jitter. Clock jitter causes uncertainty in the sampling instant of the ADC, in addition to the inherent uncertainty on the sampling instant caused by the part itself, as specified by its aperture jitter. There is a theoretical relationship between the frequency (f) and resolution ( $2^N$ ) of a signal that needs to be sampled and the maximum amount of aperture error  $dt_{\text{max}}$  that is tolerable. The following formula shows the relation:

$$dt_{\text{max}} = 1 \div \left[ \pi f 2^{(N+1)} \right]$$

As an example, for an 8-bit converter with a 15-MHz input, the jitter needs to be kept <41 pF in order not to have changes in the LSB of the ADC output due to the total aperture error.



POST OFFICE BOX 655303 • DALLAS, TEXAS 75265



---

## PRINCIPLE OF OPERATION

### digital outputs

The output of TLV5580 is a standard binary code. Capacitive loading on the output should be kept as low as possible (a maximum loading of 10 pF is recommended) to provide best performance. Higher output loading causes higher dynamic output currents and can increase noise coupling into the device's analog front end. To drive higher loads, use an output buffer is recommended.

When clocking output data from TLV5580, it is important to observe its timing relation to CLK. Pipeline ADC delay is 4.5 clock cycles to which the maximum output propagation delay is added. See Note 6 in the specification section for more details.

### layout, decoupling and grounding rules

It is necessary for any PCB using the TLV5580 to have proper grounding and layout to achieve the stated performance. Separate analog and digital ground planes that are spliced underneath the device are advisable. TLV5580 has digital and analog terminals on opposite sides of the package to make proper grounding easier. Since there is no internal connection between analog and digital grounds, they have to be joined on the PCB. Joining the digital and analog grounds at a point in close proximity to the TLV5580 is advised.

As for power supplies, separate analog and digital supply terminals are provided on the device ( $AV_{DD}/DV_{DD}$ ). The supply to the digital output drivers is kept separate also ( $DRV_{DD}$ ). Lowering the voltage on this supply from the nominal 3.3 V to 3 V improves performance because of the lower switching noise caused by the output buffers.

Due to the high sampling rate and switched-capacitor architecture, TLV5580 generates transients on the supply and reference lines. Proper decoupling of these lines is essential. Decoupling as shown in the schematic of the TLV5580 EVM is recommended.

# TLV5580

## 8-BIT, 80 MSPS LOW-POWER A/D CONVERTER

SLAS205A – DECEMBER 1998 – REVISED JANUARY 1999

---

### TLV5580 EVALUATION MODULE

#### TLV5580 evaluation module

TI provides an evaluation module (EVM) for TLV5580. The EVM also includes a 10b 80 MSPS DAC so that the user can convert the digitized signal back to the analog domain for functional testing. Performance measurements can be done by capturing the ADC's output data.

The EVM provides the following additional features:

- Provision of footprint for the connection of an onboard crystal oscillator, instead of using an external clock input.
- Use of TLV5580 internal or external voltage references. In the case of external references, an onboard circuit is used that derives adjustable bottom and top reference voltages from a bandgap reference. Two potentiometers allow for the independent adjustments of both references. The full scale ADC range can be adjusted to the input signal amplitude.
- All digital output, control signal I/O (output enable, standby, reference powerdown) and clock I/O are provided on a single connector. The EVM can thus be part of a larger (DSP) system for prototyping.
- Onboard prototyping area with analog and digital supply and ground connections.

Figure 15 shows the EVM schematic.

The EVM is factory shipped for use in the following configuration:

- Use of external (onboard) voltage references
- External clock input

#### analog input

A signal in the range between  $V_{(REFBI)}$  and  $V_{(REFTI)}$  should be applied to avoid overflow/underflow on connector J10. This signal is onboard terminated with  $50\Omega$ . There is no onboard biasing of the signal. When using external (onboard) references, these levels can be adjusted with R7 ( $V_{(REFTI)}$ ) and R6 ( $V_{(REFBI)}$ ). Adjusting R7 causes both references to shift. R6 only impacts the bottom reference. The range of these signals for which the device is specified depends on  $AV_{DD}$  and is shown under the Recommended Operating Conditions.

Internally generated reference levels are also dependent on  $AV_{DD}$  as shown in the electrical characteristics section.

#### clock input

A clock signal should be applied with amplitudes ranging from 0 to  $AV_{DD}$  with a frequency equal to the desired sampling frequency on connector J9. This signal is onboard terminated with  $50\Omega$ . Both ADC and DAC run off the same clock signal. Alternatively the clock can be applied from terminal 1 on connector J11. A third option is using a crystal oscillator. The EVM board provides the footprint for a crystal oscillator that can be populated by the end-user, depending on the desired frequency. The footprint is compatible with the Epson EG-8002DC series of programmable high-frequency crystal oscillators. Refer to the TLV5580 EVM Settings for selecting between the different clock modes.



## TLV5580 EVALUATION MODULE

### power supplies

The board provides seven power supply connectors (see Table 2). For optimum performance, analog and digital supplies should be kept separate. Using separate supplies for the digital logic portion of TLV5580 ( $DV_{DD}$ ) and its output drivers ( $DRV_{DD}$ ) benefits dynamic performance, especially when  $DRV_{DD}$  is put at the minimum required voltage (3 V), while  $DV_{DD}$  might be higher (up to 3.6 V). This lowers the switching noise on the die caused by the output drivers.

**Table 2. Power Supplies**

| SIGNAL NAME | CONNECTOR | BOARD LABEL | DESCRIPTION   |
|-------------|-----------|-------------|---|
| DRV3        | J1        | 3DRV        | 3.3 V digital supply for TLV5580 (digital output drivers)   |
| DV3         | J2        | 3VD         | 3.3 V digital supply for TLV5580 (digital logic) and peripherals  |
| DV5         | J3        | 5VD         | 5 V digital supply for D/A converter and peripherals  |
| AV3         | J4        | 3VA         | 3.3 V analog supply for TLV5580   |
| AV5         | J5        | 5VA         | 5 V analog supply for onboard reference circuit and D/A converter. Can be left unconnected if internal references are used and no D/A conversion is required. |
| AV+12       | J6        | 12VA        | 12 V analog supply for onboard reference circuit. Can be left unconnected if internal references are used.  |
| AV-12       | J7        | -12VA       | -12 V analog supply for onboard reference circuit. Can be left unconnected if internal references are used.   |

### voltage references

SW1 and SW2 switch between internal and external top and bottom references respectively. The external references are onboard generated from a stable bandgap-derived 3.3 V signal (using TI's TPS7133 and quad-opamp TLE2144). They can be adjusted via potentiometers R6 ( $V_{(REFBI)}$ ) and R7 ( $V_{(REFTI)}$ ). It is advised to power down the internal voltage references by asserting PWN\_REF when onboard references are used.

The references are measured at test points TP3 ( $V_{(REFB)}$ ) and TP4 ( $V_{(REFT)}$ ).

### DAC output

The onboard DAC is a 10-bit 80 MSPS converter. It is connected back-to-back to the TLV5580. While the user could use its analog output for measurements, the DAC output is directly connected to connector J8 and does not pass through an analog reconstruction filter. So mirror spectra from aliased signal components feed through into the analog output.

For this reason and to separate ADC and DAC contributions, performance measurements should be made by capturing the ADC output data available on connector J11 and not by evaluating the DAC output.

# TLV5580

## 8-BIT, 80 MSPS LOW-POWER A/D CONVERTER

SLAS205A – DECEMBER 1998 – REVISED JANUARY 1999

### TLV5580 EVALUATION MODULE

#### TLV5580 EVM settings

##### clock input settings

| REFERENCE DESIGNATOR | FUNCTION  |
|----------------------|---|
| W1                   | Clock selection switch<br>1–2 J11: clock from pin1 on J11 connector<br>2–3 J9: clock from J9 SMA connector  |
| W2                   | Clock source switch<br><input checked="" type="checkbox"/> XTL: clock from onboard crystal oscillator<br><input type="checkbox"/> CLK: clock from pin 1 on J11 connector (if W1/1–2) or J9 SMA connector (if W1/2–3)<br>NOTE: If set to XTL and a XTL oscillator is populated, no clock signal should be applied to J9 or J11, depending on the W1 setting. |
| W3                   | Clock output switch<br>1–2 Rising: clock output on J11 connector is the same phase as the clock to the digital output buffer. Data changes on rising CLK edge.<br>2–3 Falling: clock output on J11 connector is the opposite phase as the digital output buffer. Data changes on falling CLK edge.  |

##### reference settings

| REFERENCE DESIGNATOR | FUNCTION  |
|----------------------|---|
| SW1                  | REFT external/internal switch<br><input checked="" type="checkbox"/> REFT internal: REFT from TLV5580 internal reference<br><input type="checkbox"/> REFT external: REFT from onboard voltage reference circuit |
| SW2                  | REFB external/internal switch<br><input checked="" type="checkbox"/> REFB internal: REFB from TLV5580 internal reference<br><input type="checkbox"/> REFB external: REFB from onboard voltage reference circuit |

##### control settings

| REFERENCE DESIGNATOR | FUNCTION   |
|----------------------|--|
| W4                   | TLV5580 and digital output buffer output enable control (1)<br><input checked="" type="checkbox"/> 5580-574 $\overline{OE}$ -connected: Connects $\overline{OE}$ s of TLV5580 and digital output buffer (574 buffer). Use this when no board-external $\overline{OE}$ is used. In addition, close W5 to have both $\overline{OE}$ s permanently enabled.<br><input type="checkbox"/> 5580-574 $\overline{OE}$ -disconnected: Disconnects $\overline{OE}$ s of TLV5580 and digital output buffer (574 buffer). The $\overline{OE}$ for the output buffer needs to be pulled low from pin 5 on J11 connector to enable. The $\overline{OE}$ for TLV5580 is independently controlled from pin 7 on J11 connector (W5 open) or is permanently enabled if W5 is closed. |
| W5                   | TLV5580 and digital output buffer output enable control (2)<br><input checked="" type="checkbox"/> 5580 $\overline{OE}$ to GND: Connects $\overline{OE}$ s of TLV5580 to GND. Additionally connects $\overline{OE}$ of 74ALS574 to GND if W4 is 5580-574 $\overline{OE}$ -connected.<br><input type="checkbox"/> 5580 $\overline{OE}$ external: Enables control of $\overline{OE}$ of TLV5580 via pin 7 on J11 connector. When taken high (internal pulldown) the output can be disabled.  |
| W6                   | TLV5580 STDBY control<br><input checked="" type="checkbox"/> Stdby: STDBY is active (high).<br><input type="checkbox"/> Active: STDBY is low, via internal pulldown. STDBY can be taken high from pin 9 on J11 connector to enable standby mode.   |



TLV5580 EVALUATION MODULE

control settings (continued)

| REFERENCE DESIGNATOR | FUNCTION  |
|----------------------|---|
| W7                   | TLV5580 PWDN REF control<br><input checked="" type="checkbox"/> Pwdn_ref: PWDN_REF is active (high).<br><input type="checkbox"/> Active: PWDN_REF is low, via internal pulldown. PWDN_REF can be taken high from pin 10 on J11 connector to enable pwdn_ref mode. |
| W8                   | DAC enable<br><input checked="" type="checkbox"/> Active: D/A on<br><input type="checkbox"/> Standby: D/A off   |

# TLV5580 8-BIT, 80 MSPS LOW-POWER A/D CONVERTER

SLAS205A – DECEMBER 1998 – REVISED JANUARY 1999

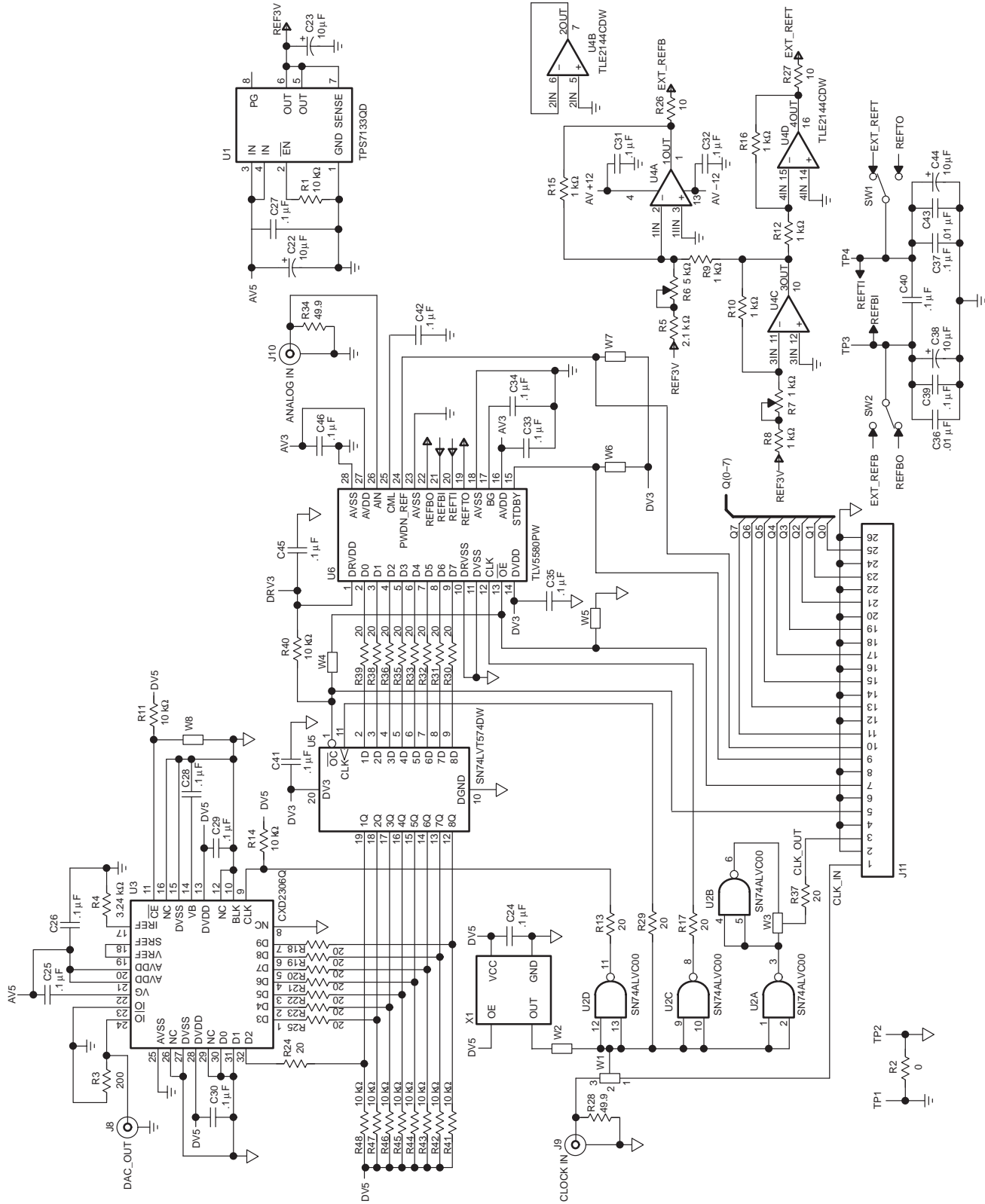

Figure 15. EVM Schematic



POST OFFICE BOX 655303 • DALLAS, TEXAS 75265

TLV5580 EVALUATION MODULE

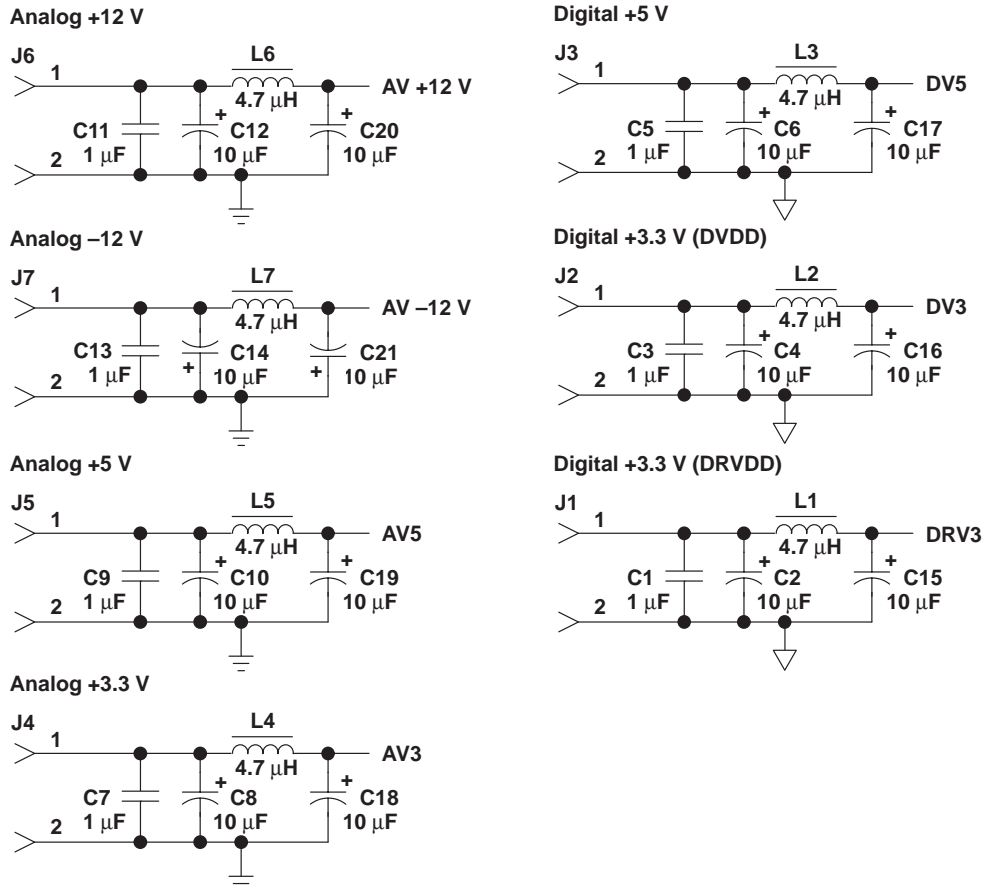
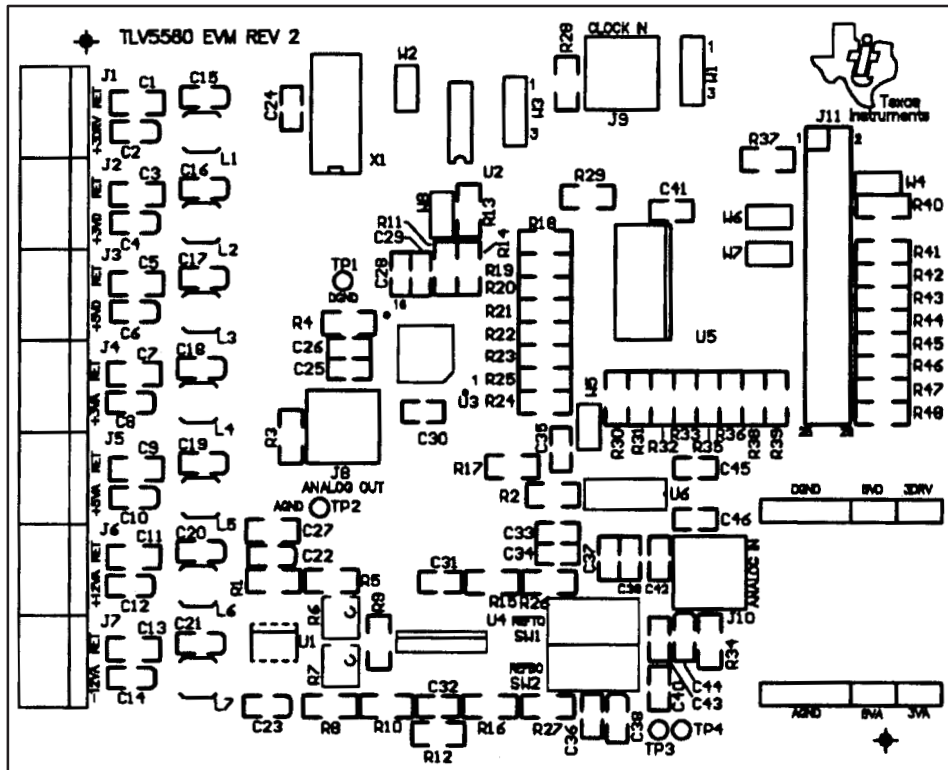

Figure 15. EVM Schematic (Continued)

# TLV5580 8-BIT, 80 MSPS LOW-POWER A/D CONVERTER

SLAS205A – DECEMBER 1998 – REVISED JANUARY 1999

## TLV5580 EVALUATION MODULE



Top Overlay

Figure 15. EVM Schematic (Continued)



TLV5580 EVALUATION MODULE

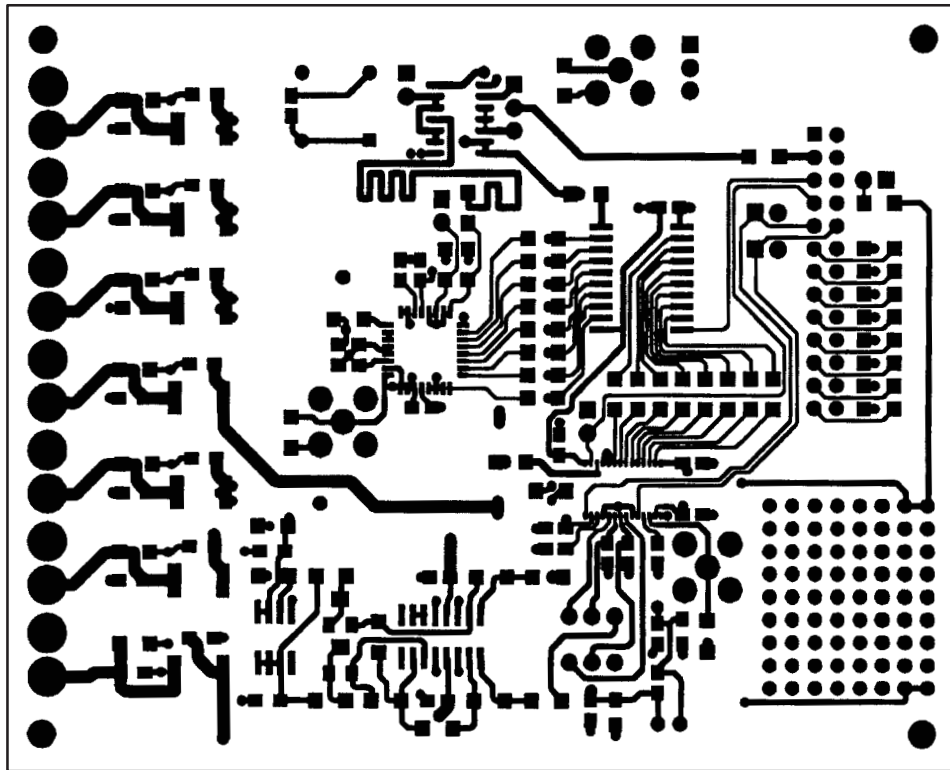

Top Layer

Figure 15. EVM Schematic (Continued)

TLV5580  
8-BIT, 80 MSPS LOW-POWER A/D CONVERTER

SLAS205A – DECEMBER 1998 – REVISED JANUARY 1999

TLV5580 EVALUATION MODULE

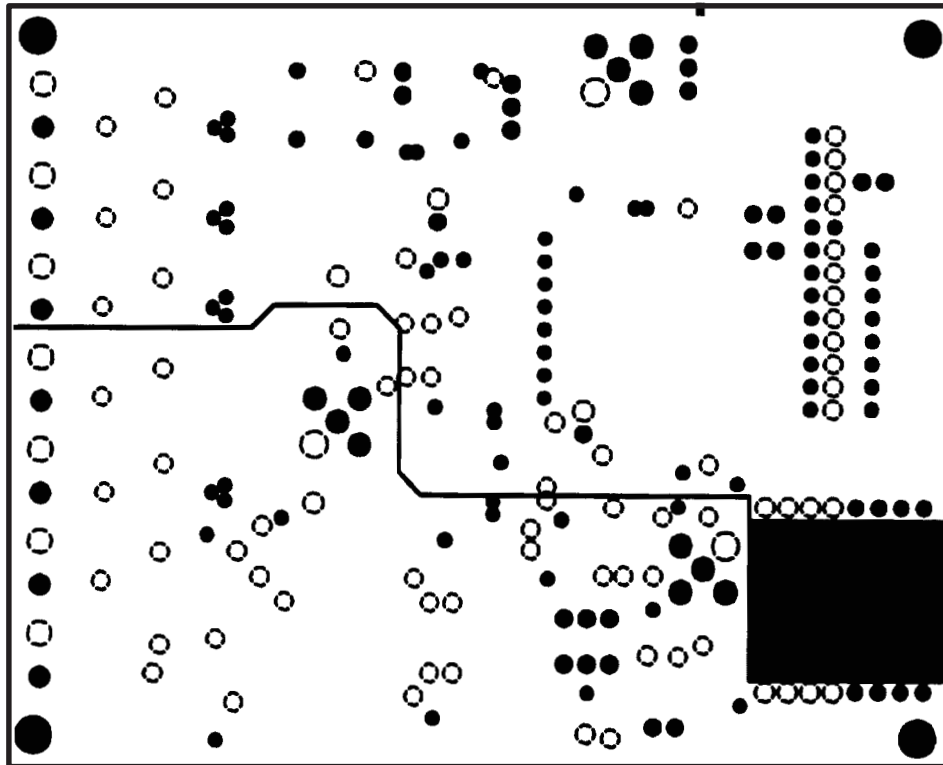

Internal Plane 1

Figure 15. EVM Schematic (Continued)

TLV5580 EVALUATION MODULE

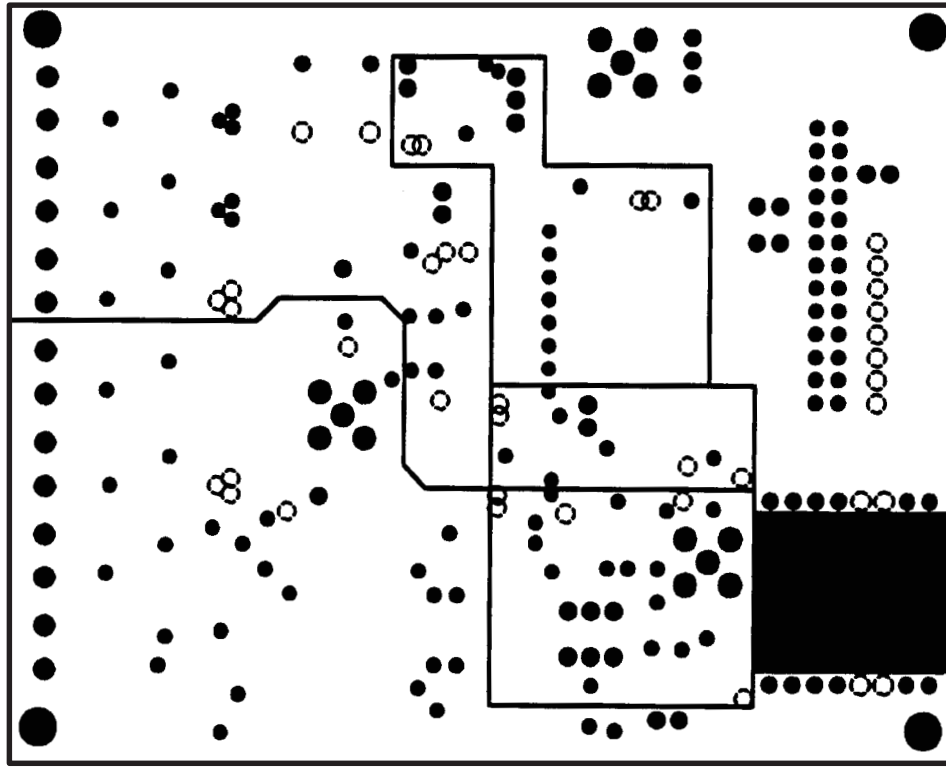

Internal Plane 2

Figure 15. EVM Schematic (Continued)

# TLV5580 8-BIT, 80 MSPS LOW-POWER A/D CONVERTER

SLAS205A – DECEMBER 1998 – REVISED JANUARY 1999

## TLV5580 EVALUATION MODULE

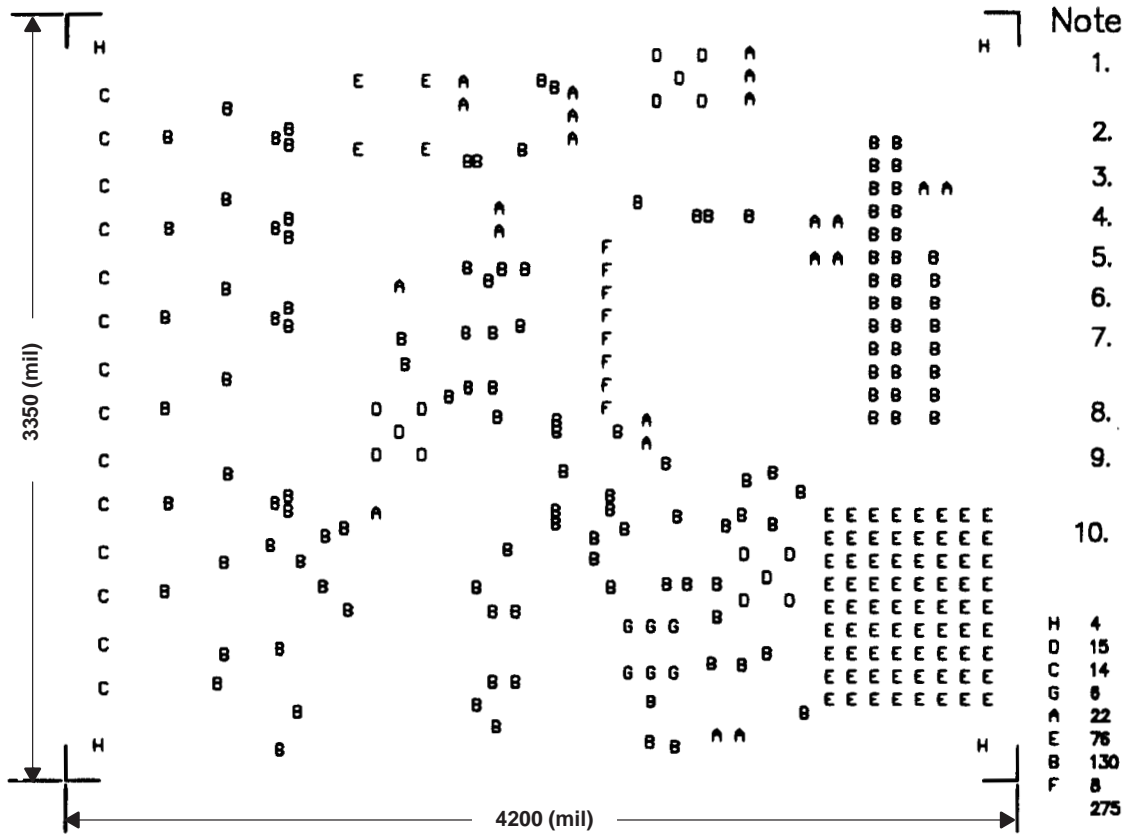

Drill Drawing for Through Hole

Figure 15. EVM Schematic (Continued)

TLV5580 EVALUATION MODULE

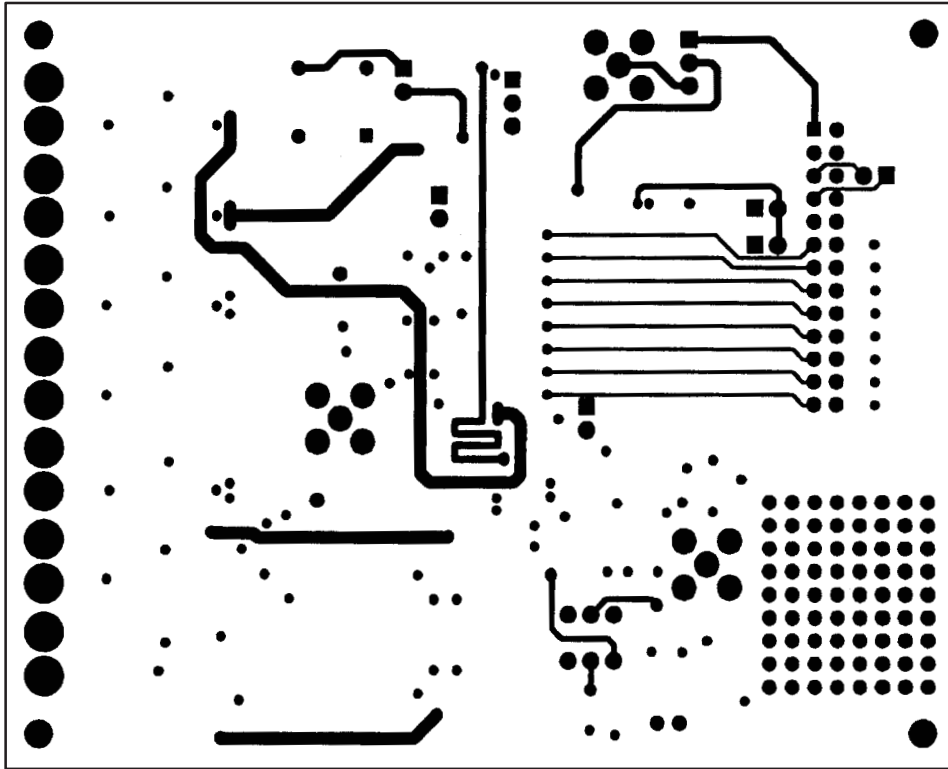

Bottom Layer

Figure 15. EVM Schematic (Continued)

# TLV5580

## 8-BIT, 80 MSPS LOW-POWER A/D CONVERTER

SLAS205A – DECEMBER 1998 – REVISED JANUARY 1999

### TLV5580 EVALUATION MODULE

Table 3. TLV5580EVM Bill of Material

| QTY. | REFERENCE DESIGNATOR   | VALUE        | SIZE        | DESCRIPTION                           | MANUFACTURER/<br>PART NUMBER†             |
|------|--|--------------|-------------|---------------------------------------|---|
| 7    | C1, C11, C13, C3, C5, C7, C9   | 1 $\mu$ F    | 1206        | ceramic multilayer capacitor          | Any                                       |
| 18   | C10, C12, C14, C15, C16, C17, C18, C19, C2, C20, C21, C22, C23, C4, C6, C8, C38, C44               | 10 $\mu$ F   | 3216        | 16 V, 10 $\mu$ F, tantalum capacitor  | Any                                       |
| 2    | C36, C43   | 0.01 $\mu$ F | 805         | Ceramic multilayer                    | Any                                       |
| 19   | C24, C25, C26, C27, C28, C29, C30, C31, C32, C33, C34, C35, C37, C39, C40, C41, C42, C45, C46      | 0.1 $\mu$ F  | 805         | Ceramic multilayer capacitor          | Any                                       |
| 7    | J1, J2, J3, J4, J5, J6, J7   | Screw Con    |             | 2 terminal screw connector            | Lumberg<br>KRMZ2                          |
| 3    | J10, J8, J9  | SMA          |             | PCM mount, SMA Jack                   | Johnson Components<br>142-0701-206        |
| 1    | J11  | IDC26        |             | 13" $\times$ 2.025" square pin header | Samtec<br>TSW-113-07-L-D                  |
| 7    | L1, L2, L3, L4, L5, L6, L7   | 4.7 $\mu$ H  |             | 4.7 $\mu$ H DO1608C-472-Coil Craft    | Coil Craft<br>DO1608-472                  |
| 1    | R2   | 0            | 1206        | Chip resistor                         | Any                                       |
| 2    | R26, R27   | 10           | 1206        | Chip resistor                         | Any                                       |
| 12   | R1, R11, R14, R40, R41, R42, R43, R44, R45, R46, R47, R48  | 10 K         | 1206        | Chip resistor                         | Any                                       |
| 6    | R10, R12, R15, R16, R8, R9   | 1 K          | 1206        | Chip resistor                         | Any                                       |
| 1    | R5   | 2.1 K        | 1206        | Chip resistor                         | Any                                       |
| 20   | R13, R17, R18, R19, R20, R21, R22, R23, R24, R25, R29, R30, R31, R32, R33, R35, R36, R37, R38, R39 | 20           | 1206        | Chip resistor                         | Any                                       |
| 1    | R3   | 200          | 1206        | Chip resistor                         | Any                                       |
| 1    | R4   | 3.24 K       | 1206        | Chip resistor                         | Any                                       |
| 2    | R28, R34   | 49.9         | 1206        | Chip resistor                         | Any                                       |
| 1    | R6   | 5 K          |             | 4 mm SM pot-top adjust                | Bourns<br>3214W-5K                        |
| 1    | R7   | 1 K          |             | 4 mm SM pot-top adjust                | Bourns<br>3214W-1K                        |
| 2    | SW1, SW2   | SPDT         |             | C&K tiny series–slide switch          | C&K<br>TS01CLE                            |
| 4    | TP1, TP2, TP3, TP4   | TP           |             | Test point, single 0.025" pin         | Samtec<br>TSW-101-07-L-S<br>or equivalent |
| 1    | U3   | CXD2306Q     |             |                                       | Sony<br>CXD2306Q                          |
| 1    | U2   | SN74ALVC00D  | 14-SOIC (D) | Quad 2-input positive NAND            | Texas Instruments<br>SN74ALVC00D          |
| 1    | U5   | SN74LVT574DW | 20-SOP (DW) |                                       | Texas Instruments<br>SN74LVT574DW         |

† Manufacturer and part number data for reference only. Equivalent parts might be substituted on the EVM.



POST OFFICE BOX 655303 • DALLAS, TEXAS 75265

**TLV5580**  
**8-BIT, 80 MSPS LOW-POWER A/D CONVERTER**

SLAS205A – DECEMBER 1998 – REVISED JANUARY 1999

**TLV5580 EVALUATION MODULE**

**Table 3. TLV5580EVM Bill of Material (Continued)**

| QTY. | REFERENCE DESIGNATOR   | VALUE      | SIZE          | DESCRIPTION                     | MANUFACTURER/<br>PART NUMBER†                  |
|------|------------------------|------------|---------------|---------------------------------|--|
| 1    | U4                     | TLE2144CDW | 16-SOP(D)     | Quad op amp                     | Texas Instruments<br>TLE2144CDW/<br>TLE2144IDW |
| 1    | U6                     | TLV5580PW  | 28-TSSOP (PW) |                                 | Texas Instruments<br>TLV5580PW                 |
| 1    | U1                     | TPS7133    | 8-SOP(D)      | Low-dropout voltage regulator   | Texas Instruments<br>TPS7133QD                 |
| 6    | W2, W4, W5, W6, W7, W8 | SPST       |               | 2 position jumper, 0.1" spacing | Samtec<br>TSW-102-07-L-S<br>or equivalent      |
| 2    | W1, W3                 | DPFT       |               | 3 position jumper, 0.1" spacing | Samtec<br>TSW-103-07-L-S<br>or equivalent      |
| 1    | X1                     | NA         |               | Crystal oscillator              | Epson<br>SG-8002DC series                      |

† Manufacturer and part number data for reference only. Equivalent parts might be substituted on the EVM.

# TLV5580 8-BIT, 80 MSPS LOW-POWER A/D CONVERTER

SLAS205A – DECEMBER 1998 – REVISED JANUARY 1999

## MECHANICAL DATA

DW (R-PDSO-G\*\*)

PLASTIC SMALL-OUTLINE PACKAGE

16 PIN SHOWN

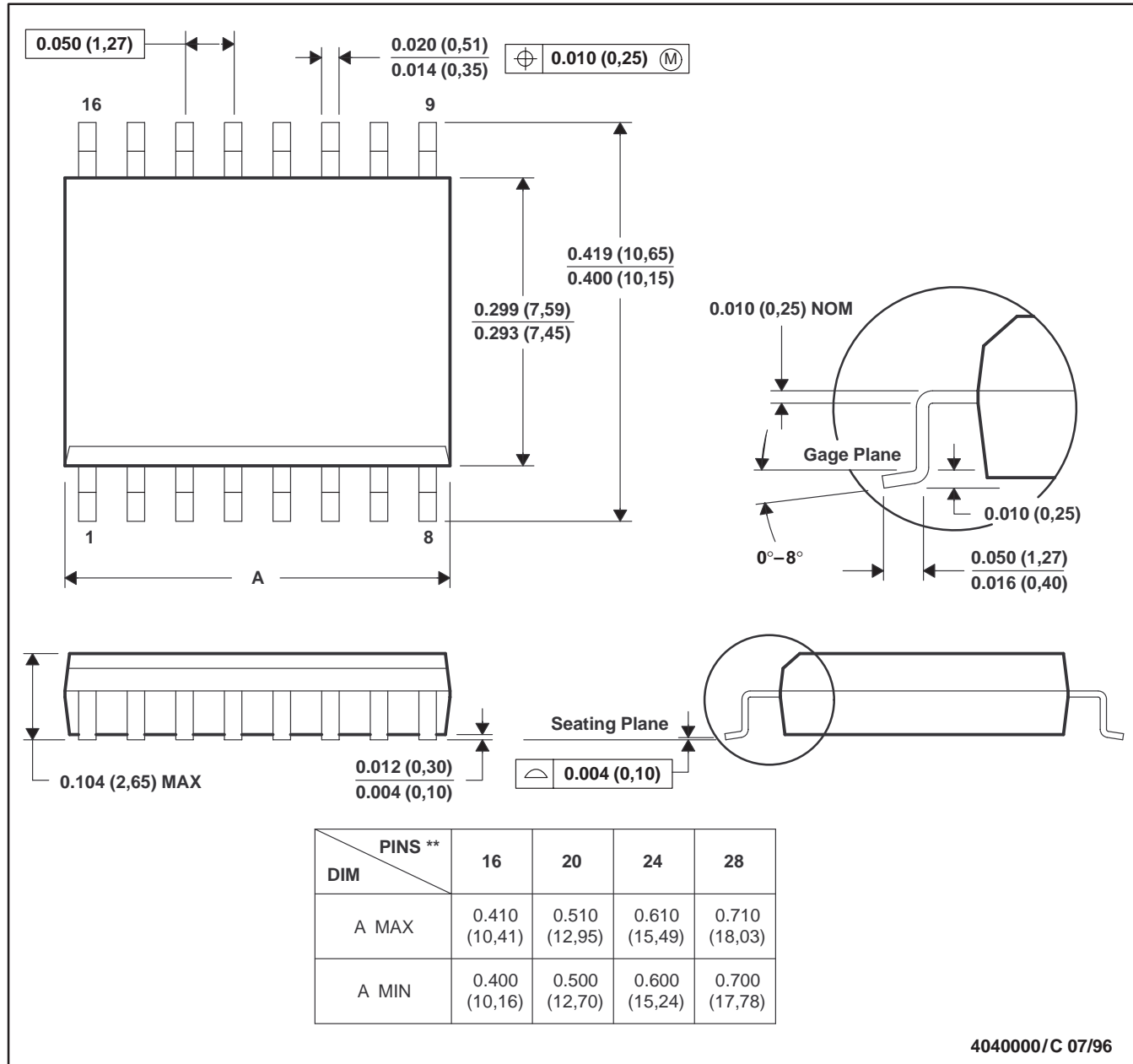

4040000/C 07/96

- NOTES: A. All linear dimensions are in inches (millimeters).  
 B. This drawing is subject to change without notice.  
 C. Body dimensions do not include mold flash or protrusion not to exceed 0.006 (0,15).  
 D. Falls within JEDEC MS-013



MECHANICAL DATA

PW (R-PDSO-G\*\*)

PLASTIC SMALL-OUTLINE PACKAGE

14 PIN SHOWN

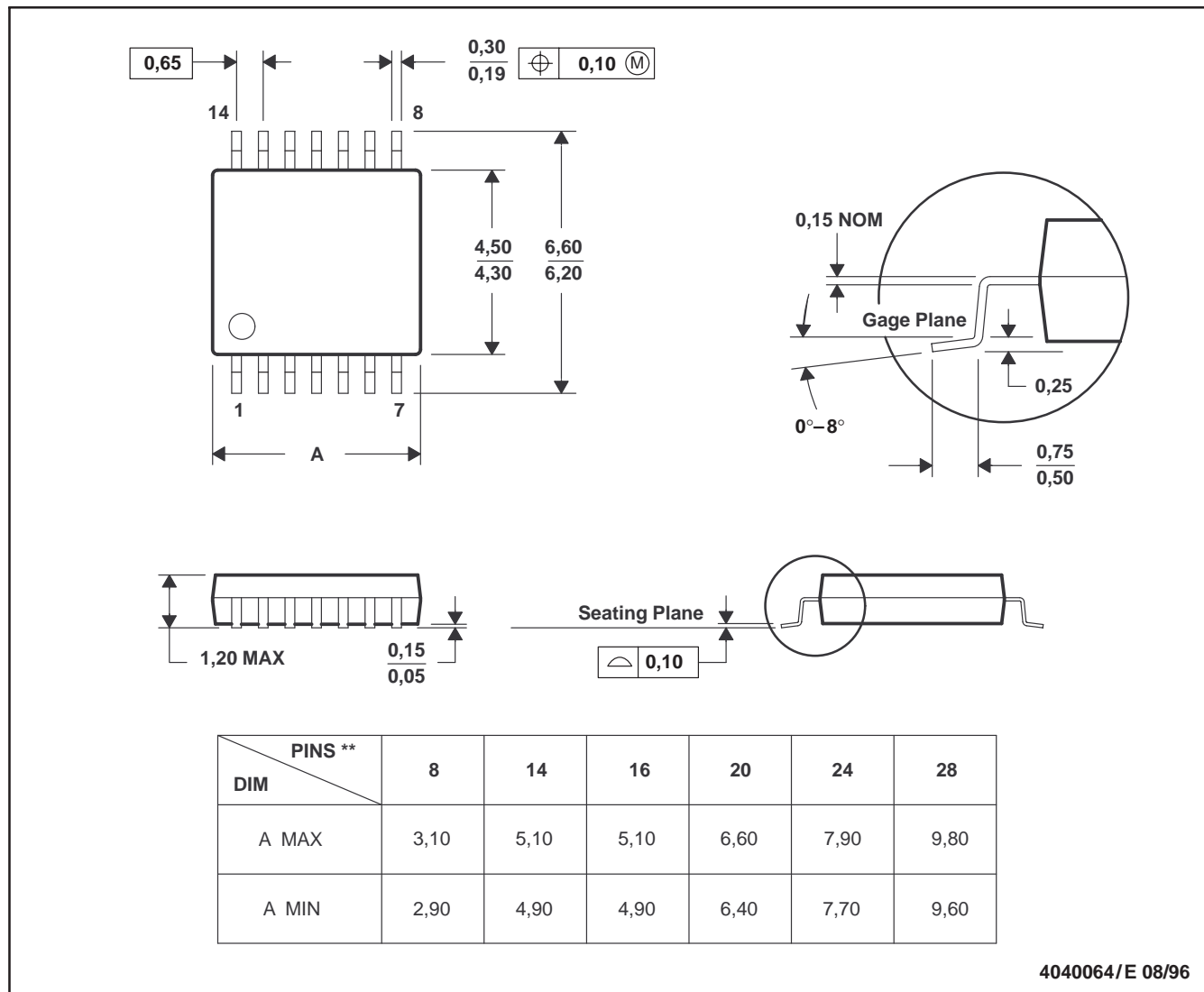

- NOTES: A. All linear dimensions are in millimeters.  
 B. This drawing is subject to change without notice.  
 C. Body dimensions do not include mold flash or protrusion not to exceed 0,15.  
 D. Falls within JEDEC MO-153

## **IMPORTANT NOTICE**

Texas Instruments and its subsidiaries (TI) reserve the right to make changes to their products or to discontinue any product or service without notice, and advise customers to obtain the latest version of relevant information to verify, before placing orders, that information being relied on is current and complete. All products are sold subject to the terms and conditions of sale supplied at the time of order acknowledgement, including those pertaining to warranty, patent infringement, and limitation of liability.

TI warrants performance of its semiconductor products to the specifications applicable at the time of sale in accordance with TI's standard warranty. Testing and other quality control techniques are utilized to the extent TI deems necessary to support this warranty. Specific testing of all parameters of each device is not necessarily performed, except those mandated by government requirements.

**CERTAIN APPLICATIONS USING SEMICONDUCTOR PRODUCTS MAY INVOLVE POTENTIAL RISKS OF DEATH, PERSONAL INJURY, OR SEVERE PROPERTY OR ENVIRONMENTAL DAMAGE ("CRITICAL APPLICATIONS"). TI SEMICONDUCTOR PRODUCTS ARE NOT DESIGNED, AUTHORIZED, OR WARRANTED TO BE SUITABLE FOR USE IN LIFE-SUPPORT DEVICES OR SYSTEMS OR OTHER CRITICAL APPLICATIONS. INCLUSION OF TI PRODUCTS IN SUCH APPLICATIONS IS UNDERSTOOD TO BE FULLY AT THE CUSTOMER'S RISK.**

In order to minimize risks associated with the customer's applications, adequate design and operating safeguards must be provided by the customer to minimize inherent or procedural hazards.

TI assumes no liability for applications assistance or customer product design. TI does not warrant or represent that any license, either express or implied, is granted under any patent right, copyright, mask work right, or other intellectual property right of TI covering or relating to any combination, machine, or process in which such semiconductor products or services might be or are used. TI's publication of information regarding any third party's products or services does not constitute TI's approval, warranty or endorsement thereof.